

Nitrotel FTTH Solution

Our solution for deploying fiber optics to the home is the most robust and reliable on the market.

CABLES

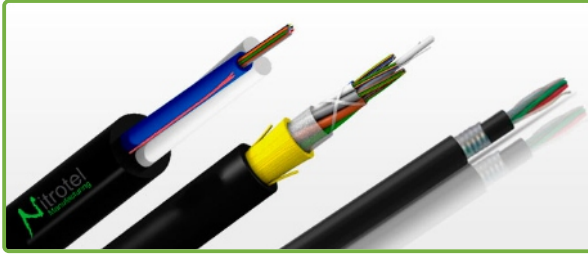

FIBER CONNECTIVITY



SPLICING



TEST AND TOOLS



MEDIA CONVERTERS



OUTDOOR CABINETS



PRODUCT DATA SHEET

ADSS Cable

All Dielectric Self-supporting Aerial Cable (ADSS)

The Nitrotel ADSS cable encases SM fibers in plastic tubes, wrapped around a non-metallic central strength member (FRP) to create a tight circular core. Tubes are filled and water-blocking materials are inserted. It's then covered with a HDPE outer sheath.



Features

- Easy installation
- Excellent corrosion resistance
- Light weight and small diameter
- Span from 100 to 400m
- 6 to 288 fibers, SM G652D or G655
- The life expectancy is over 25 years
- Up to 150m span single jacket
- Color code TIA-598
- Span over 150m double jacket

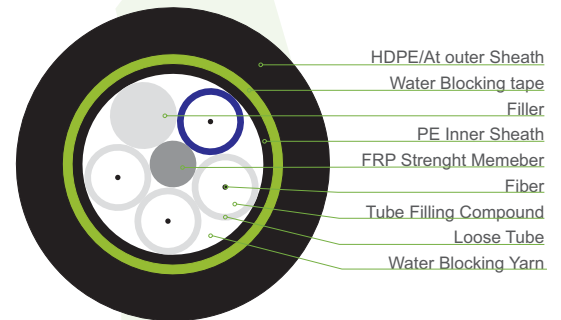

Ordering Information

NT-ADSS-XXM-XX-X

SPAN 100-150-200 300-400	Glass: G652D(S), G655(B) Fiber Count 6 - 12 - 24 - 36 48 - 72 - 96 - 144
--------------------------------	---

Other configuration available under request
Example NT-ADSS-SM-100M-24S Spam: 100m 24 Fibers SM G652D
MAT: 2,950N Cable Diameter: 10.0mm Single Jacket

All Dielectric Self-Supporting Unitube Cable

In the Nitrotel ASU cable, fibers are positioned in central the loose tube which is made of high modulus plastic materials, with two strength member (FRP) into a compact and circular cable core. The cable is completed with a PE outer sheath.



Features

- 4 to 24 fibers, SM G652D
- Easy installation
- Light weight, small diameter and most economical than ADSS cables
- Maximum span 80 to 100 meters
- Application: Aerial

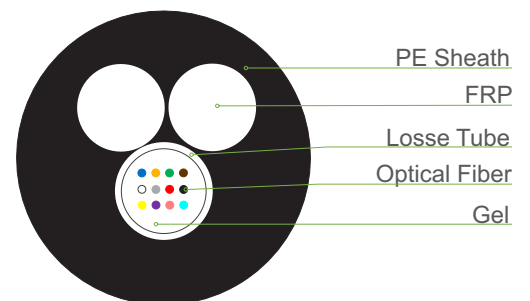

Ordering Information

NT-ASU-SM-XXM-XX

SPAN 100	Fiber Count 6 - 12 - 24
-------------	----------------------------

Other configuration available under request
Example NT-ASU-SM-100M-12S Spam: 100m 12 Fibers SM G652D



PRODUCT DATA SHEET

DUCT/UNDERGROUND CABLE

Dry Core Stranded Loose Tube Cable with Non-metallic Central

In the GYFY cable, single/multimode fibers sit in plastic tubes, wrapped around a non-metallic FRP core, forming a tight circular core. For high fiber count cables, the core is covered with PE. Water-blocking yarns fill the core gaps. Finally, it's covered with a HDPE sheath.

Features

- Excellent mechanical and temperature performance guaranteed by the accurate excess fiber length
- Critical protection to fibers, based on the excellent hydrolysis resistance and strength performance of tube material and special filling compound filled in the tube
- Excellent ultraviolet prevention with HDPE sheath
- Single FRP used as the central strength member
- Special water-blocking filling compound in the loose tube
- Application: Duct/Aerial
- 6 to 144 fibers, SM G652D or G655

Ordering Information

NT-GYFY-XXS

Fiber Count
6 - 12 - 24 - 36
48 - 72 - 96 - 144

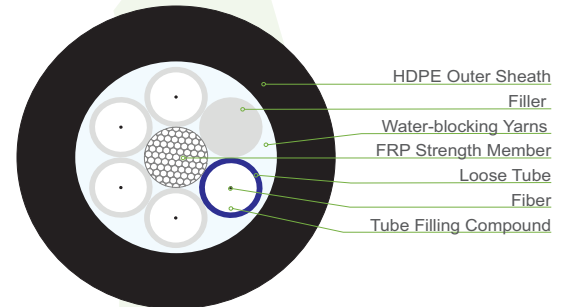

Stranded Loose Tube Cable with Steel Tape

Nitrotel armored cable are fibers in plastic tubes around a FRP core, PE-covered for high fiber count. Water-blocking PSP, HDPE sheath for protection

Features

- High mechanical and temperature performance ensured by precise excess fiber length and superior hydrolysis-resistant tube material with specialized filling compound.
- Excellent ultraviolet prevention with HDPE sheath
- Single FRP used as the central strength member
- Special water-blocking filling compound in the loose tube
- Application: Duct/Aerial
- Option double jacket
- 6 to 144 fibers, SM G652D or G655

Ordering Information

NT-GYTS-XXS

Fiber Count
6 - 12 - 24 - 36
48 - 72 - 96 - 144

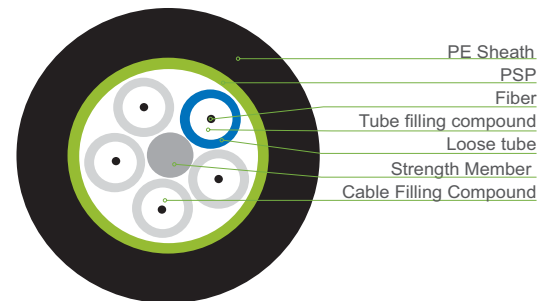

PRODUCT DATA SHEET

DROP CABLE

Drop Optical Cable Bow-Type Self-Supporting

Nitrotel bow-type drop cable: 1 or 2 color-coded optical fibers Ideal for smaller fiber counts in network ends. Protected by parallel FRP or Steel Wire strength members, finished with LSZH black jacket, white option available.

Features

- Simple structure, light weight, high tensile strength.
- Novel groove design, easily strip and splice, simplified installation and maintenance.
- Low smoke zero halogen flame retardant sheath, environment-friendly, good safety.
- Comply with standard YD/T1997-2009
- Standard Reel Length: 1 or 2kms.

Ordering Information

NT-GJYXFCH-Y1AY2 (FRP strength members)

NT-GJYXCH-Y1AY2 (Steel wire strength members)

Y1: Number Fiber 1 or 2

Y2: Type SM G657A1 (1) G657A2 (2)

Example:

NT-GJYXFCH-1A2, 2 STRANDS FRP STRENGTH MEMBER

NT-GYFXBY-8A2, 8 STRANDS STEEL WIRE STRENGTH MEMBER

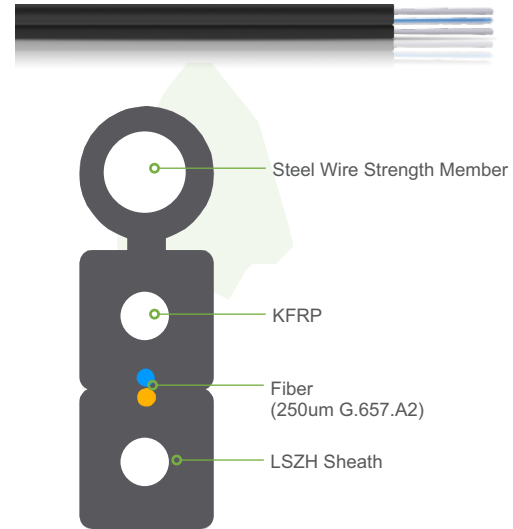

Drop Optical Cable Oval Self-Supporting Unitube Cable

Nitrotel FTTH flat aerial access unitube cable GYFXBY is suitable for FTTH aerial access application. This cable has simple construction and stable performance. It is an all-dielectric self-supporting cable which prevents thunder access.

Features

- Simple structure, light weight, high tensile strength.
- Novel groove design, easily strip and splice, Simplified installation and maintenance.
- Low Smoke zero halogen flame retardant sheath,
- Environment-friendly, good safety.
- Comply with standard YD/T1997-2009
- Standard Reel Length: 1 or 2kms

Ordering Information

NT-GYFBY-XX-AX

Number of fibers XX: 1 - 2 - 4 - 8 - 12

type of Glass X: G657A1 (1) G657A2 (2)

Example:

NT-GYFXBY-1A2, 1 STRANDS G657A2

NT-GYFXBY-12A1, 1 STRANDS G657A1

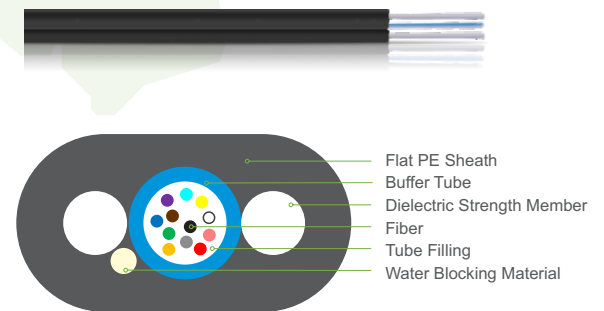

PRODUCT DATA SHEET

FTTH SUPPORT HARDWARE

DROP CLAMPS

Features

- **Secure fastening:** Clamps ensure drop cables are securely attached to mounting surfaces, preventing loosening due to environmental factors like wind or vibration.
- **Protection:** They shield drop cables from physical damage, such as accidental cuts or crushing, maintaining uninterrupted fiber optic connections.
- **Aesthetics:** Clamps contribute to a tidy appearance by neatly securing cables along their route, enhancing the overall aesthetics of the installation.
- **Maintenance accessibility:** Properly secured cables facilitate easier identification and access for maintenance or repairs, minimizing downtime and service disruptions.

NTFH-SPC-06



Product size: 125*20*35mm
Product material: Polyamide 6 + 201 stainless steel
Bearing tensile: 0.5 KN
Applicable wire diameter: ϕ 2-5mm

NTFH-SPC-09



Product size: 200*22*27mm
Product material: Polyamide 6 + 201 stainless steel
Bearing tensile: 0.9 KN
Applicable wire diameter: ϕ 2-8mm

NTFH-SPC-10



Product size: 130*20*15mm
Product material: Polyamide 6 + 201 stainless steel
Bearing tensile: 0.6 KN
Applicable wire diameter: ϕ 2-8mm

ADSS TENSION CLAMPS

Features

- **Secure Fastening:** Engineered to firmly fasten drop cables by applying tension, ensuring reliable attachment.
- **Adjustable Tension:** Typically features an adjustable mechanism for precise tension control, ensuring optimal cable security.
- **Durable Construction:** Constructed with robust materials to withstand environmental conditions, ensuring long-term reliability.
- **Cable Security Focus:** Primarily concentrates on securing the cable and maintaining tension to prevent any loosening or movement.

NTFH-PGC-01



Product size: 180*65*35mm
Product material: Polyamide 6 or 66 +201 Galvanized steel
Bearing tensile: 1.1 KN or 2.5 KN
Applicable wire diameter: ϕ 2-10 mm

NTFH-PGC-03



Product size: 180*65*35mm
Product material: Polyamide 6 or 66 +201 stainless steel
Bearing tensile: 3.5 KN
Applicable wire diameter: ϕ 4-12 mm

NTFH-PGC-06



Product size: 385*80*40mm
Product material: Polyamide 6 or 66 +201 stainless steel, Aluminium
Bearing tensile: 15 KN
Applicable wire diameter: ϕ 8-14 mm



ADSS SUSPENSION CLAMPS

Features

- **Secure Fastening:** Engineered for securely fastening drop cables by applying tension, ensuring a reliable connection.
- **Adjustable Tension:** Typically equipped with an adjustable mechanism for precise tension control, optimizing cable security.
- **Durable Construction:** Built with robust materials to withstand environmental conditions, ensuring long-lasting reliability.
- **Easy Installation:** Designed for straightforward installation, streamlining the deployment process in FTTH setups.

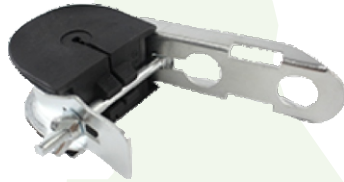

NTFH-TGC-01

Product size: 135*80*35mm
Product material: Thermo-Plastic-Rubbermaterial+ Galvanized steel
Bearing tensile: 3.8 KN
Applicable wire diameter: ϕ 5-8 mm

NTFH-TGC-02

Product size: 135*80*35mm
Product material: Thermo-Plastic-Rubbermaterial+ Galvanized steel
Bearing tensile: 3.8 KN
Applicable wire diameter: ϕ 10-15 mm

NTFH-TGC-03

Product size: 135*80*35mm
Product material: Thermo-Plastic-Rubbermaterial+ Galvanized steel
Bearing tensile: 3.8 KN
Applicable wire diameter: ϕ 8-12 mm

ADSS PREFORM SHORT SPAN (UP TO 100M)

Features

- **Self-supporting:** No need for extra support structures, simplifying installation.
- **Lightweight:** Easy to handle and install, especially in challenging environments.
- **Electrical interference immunity:** Fully dielectric construction ensures protection against interference.
- **Reliability:** Robust design ensures dependable data transmission, even in harsh conditions.



NTFPF-95

Product size: 700 mm
Product material: Preformed Dead End short with U-Clevis and timble
Bearing tensile: 311-444 N
Applicable wire diameter: ϕ 9.0-9.5mm

NTFPF-105

Product size: 850 mm
Product material: Preformed Dead End short with U-Clevis and timble
Bearing tensile: 311-444 N
Applicable wire diameter: ϕ 9.6-10.5mm

NTFPF-115

Product size: 1000 mm
Product material: Preformed Dead End short with U-Clevis and timble
Bearing tensile: 311-444 N
Applicable wire diameter: ϕ 10.6-11.6mm

NTFPF-125

Product size: 760 mm
Product material: Preformed Dead End short with U-Clevis and timble
Bearing tensile: 311-444 N
Applicable wire diameter: ϕ 11.7-12.8mm



PRODUCT DATA SHEET

SPLICE CLOSURE

Mini Dome type Splice Closure 4 In-Out Ports

Nitrotel supplies high quality fiber optic splice closures. Our dome type closures have the versatility and features that make it a perfect choice for fiber-to-the-premise networks.

The closure is an operable box which is made of high-tension ABS industrial plastic + PP which make it resistant to water, fire and shock. The dome and the end plate are sealed with rubber material and fixed tightly by a hoop. 4 ports cable with mechanical seal (option oval port). Protection IP68.

Dimension (mm)	Φ190 x 300
Weight (kg)	1.2
Cable diameter (mm)	Φ 7 - Φ21
Cable Entry & Exit	3-port + 1 Oval
Max. capacity of cores per splice tray	12
Max. capacity of splice tray / closure	4 pcs splice tray.
Max. capacity of cores	48 cores
Sealing structure	mechanical seal

Order Information

NT-FOSC-V004-XXC-M
Splices
24 - 48



Dome type Splice Closure 4-6 In-Out Ports

Nitrotel supplies high quality fiber optic splice closures. Our dome type closures have the versatility and features that make it a perfect choice for fiber-to-the-premise networks. The closure is an operable box which is made of high-tension ABS+PP which make it resistant to water, fire and shock. The dome and the end plate are sealed with rubber material and fixed tightly by a hoop. 4 or 6 round ports with mechanical seal. Protection IP68.

Dimension (mm)	Φ1205 x 420
Weight (kg)	1.96
Cable diameter (mm)	Φ 7 - Φ21
Cable Entry & Exit	4 or 6 port
Max. capacity of cores per splice tray	24
Max. capacity of splice tray / closure	6 pcs splice tray.
Max. capacity of cores	144 cores
Sealing structure	Mechanical seal

Order Information

NT-FOSC-V00X-XXC
Splice
24 - 48 - 72 - 96 - 144
x(ports): 4,5, 6, 7



Horizontal Splice Closure — 2 Ports

Nitrotel provides high-quality fiber optic splice closures, compact design with 4 cable ports. Applicable for $\Phi 8\sim 12\text{mm}$ cable. Could be installed with 2 or 32 12F trays, with max capacity 36F for single core fiber. IP68 grade protection.

Features

- May be used for all fiber optic cable
- Sheath retention & central strength member termination system included.
- Ribbed closure construction-lightweight plastic offers strength and resistance to chemical and U.V attack
- Installation and reentry with a minimum of tools
- Re-enterable and re-usable.
- Protection class: Ip68.

Ordering Information

NT-FOSC-H004-24F-M
2 Splice trays

NT-FOSC-H004-36F-M
3 Splice trays



Horizontal Splice Closure 4, 6, 8 ports

The closure has 4, 6 or 8 cable ports in total. Applicable for $\Phi 10\sim 20\text{mm}$ cable. Could be installed with up to 6x24F trays, with max capacity 144F for single core fiber.

Features

- Mechanical seal. Protection grade: Ip68.
- It passes various environmental performance tests Including 20 cycles of high & low temperature test all kinds of chemical corrosion tests.
- Re-enterable and re-usable.
- Ribbed closure construction-lightweight plastic offers strength and resistance to chemical and U.V attack

Ordering Information

NT-FOSC-H00X-XXF

X: Ports 4, 6, 8

XX: Single Splices 24, 48, 72, 96, 120, 144
(each tray 24 splices)

Example: NT-FOSC-H006-72F
(6 ports loaded with 3 trays)



PRODUCT DATA SHEET

OPTICAL TERMINATION BOX (NAP)

Fiber Optic Termination Box IP65

Nitrotel 8-16-Port Wall or Pole Mountable Fiber Termination Box is ideal for poles, external walls, corridors, basements, and other places needing FTTH or Network Connections.

This termination box is highly, it can be outfitted with almost any fiber optic connector or splitter and can be used in a wide range of applications.

Features

- Made of high-quality ABS plastic, UV resistant.
- Can accommodate 1x4, 1x8, 1x16 PLC splitter.
- Can hold up to 8 SC simplex or 8 LC duplex adapters.
- Ingress Protection IP65, Rainfall resistant.
- Up to 16 FTTH drops, Wall and pole mounting application.

Ordering Information

NTOTB-CXXSY

Adapters/drop cables xx: 4, 8, 16

Connector termination x: UPC (U), APC (A)

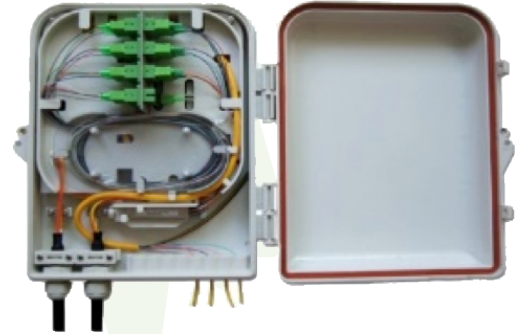

Fiber Optic Termination Box IP66

Nitrotel Wall or Pole Mountable Fiber Termination Box is ideal for poles, external walls, corridors, basements, and other places needing FTTH or Network Connections. It is made with a high impact plastic and fitted with a rubber gasket.

Features

- Material: ABS plastic, max. 16 fibers, 2pcs splice tray.
- Can load 16pcs SC simplex adapter.
- Can load PLC 2* 1:8 or 1:16 steel tube type splitter.
- 2pcs cable ports (more under request)
- 16pcs drop cable ports.
- Waterproof, outdoor aerial hanged, Ip66.
- Wall mounting and pole mounting application.

Ordering Information

NTOTB-02P16DX

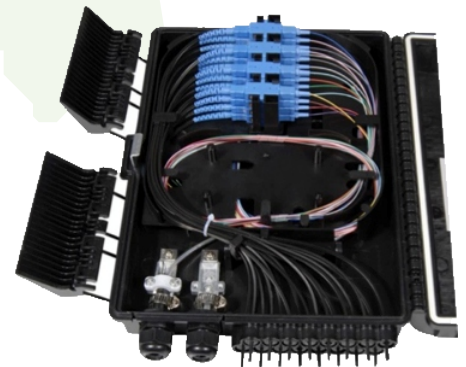

Fiber Optics Termination Box Aerial IP66

This is a fiber optic terminal box that has two side doors for loading fiber optic splitter & fiber optic adapter, fiber splicing and fiber distribution. It is an outdoor aerial messenger handled application.

Features

- Material: ABS plastic, max. 24 fibers, 2 pcs splice tray.
- Can load 16 pcs SC simplex adapter (APC or UPC).
- Can load PLC 2* 1:8 or 1:16 steel tube type splitter.
- 8 pcs cable ports (4 pcs Φ 14mm, 4 pcs Φ 10mm),
- 16 pcs drop cable ports.
- Waterproof, outdoor aerial hanged, IP66.
- Two doors: A side door for fiber splicing, B side door for cable management.

Ordering Information

NTOTB-08P16DX-AR



Horizontal Splice Closure 4, 6, 8 ports

Nitrotel OTB+ is our solution Wall or Pole Mountable Handhole (IP68) Fiber Termination, with external connection Mini-SC GR-3120. It is made with a high impact ABS plastic and fitted with a rubber gasket. It is also UV resistant and rainfall resistant. Standard 16 SC termination with or w/o splitter installed and comes with 4 splice trays.

Features

- Total enclosed structure.
- Material: PC+ABS, wet-proof, water-proof, dust-proof, anti aging, protection level up to IP68
- Cable, pigtailed are running through own path without disturbing each other, MINI-SC waterproof adapter installation, easy maintenance.
- Distribution panel can be flipped up, feeder cable can be placed in a cup-joint way, easy for maintenance and installation.
- Cabinet can be installed by the way of wall-mounted or pole-mounted.

Ordering Information

NTOTB-02P16DX-IP68



PRODUCT DATA SHEET

CABLE ASSEMBLIES

Mini Steel tube PLC Splitter

PLC (Planar Lightwave Circuits) splitters are developed provide low-cost solution for optical signal distribution. Nitrotel's Mini steel tube PLC Splitter family has 1x2, 1x4, 1x8, 1x16, 1x32, 2x2, 2x4, 2x8 and 2x16, which are tailored to different applications. It is widely used in PON, ODN, and FTTH

Features

- Low insertion loss
- Various coupling ratios
- Excellent uniformity.
- Low Polarization dependent loss
- Operation wavelength:1260nm to 1650nm
- Operating Temperature:-40oC to 85oC
- Length standard 1 meter each end (other on request)
- With or w/o connectors (APC or UPC)

Ordering Information

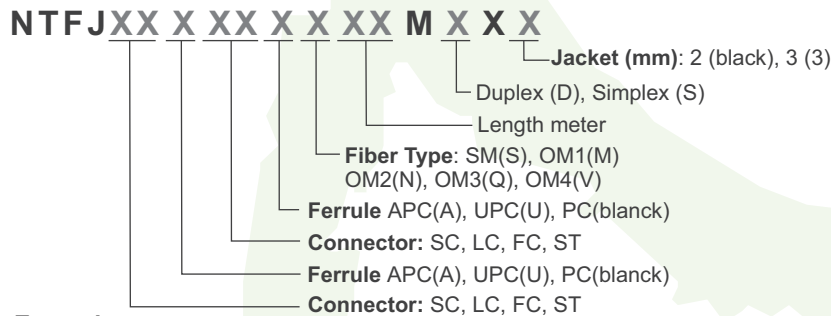

Examples

NTFJSCULCAS05MSX3: Simplex SM SC/UPC to LC/APC, 5 meters, 3mm
 NTFJSCSCQ03MDX: Duplex MM Om3, SC to SC, 3 meters, 2mm

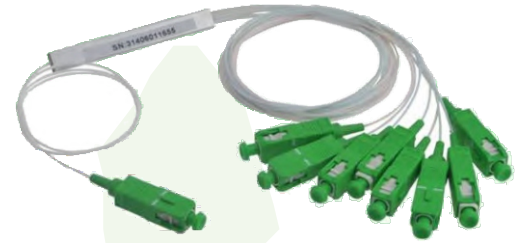

Fiber Optic Pigtail

Nitrotel offers a complete line of fiber optic pigtails. There is a 3.0 mm option Pigtails. Singlemode pigtails use our industry-recognized EasyBand®, while multimode use our MaxBand®. May be ordered PC, UPC and APC end face finish. Multimode pigtails are available with either 62.5- or 50-micron core sizes.

Features

- Connector types include SC, LC
- SM connectors are available with APC or UPC Type and standard fiber G657A1 (Others on request)
- Standard length 3 meters (other on request).
- Buffer size 900 μm (other on request)



Ordering Information

NTFP XX Y1 Y2 ZZ M

XX: Connectors: SC, LC
 Y1: Ferrule APC (A), UPC (U)
 Y2: fiber Type: G652D (S), G657A1 (A1)
 ZZ: Length meter



Fiber Optic Patchcord Simplex

Nitrotel offers a complete line of fiber optic patchcords. They have high quality components and are manufactured to comply with industry standards for optical, mechanical, and environmental performance. The wide selection of connectors, cable types, and lengths ensures that patchcords can be optimized for each unique installation.

Features:

- Connector types include SC or LC
- SM connectors are available with APC and UPC Type and standard fiber G657A1 (Others on request)
- Customized fiber lengths, connector pairs, and hybrids can be specified.
- Buffer size: 900 μm, Outer jacket 3.0 (Others on request)
- Standard Jacket LSZH (Others on request)



NTFJXX X XX X X XX M X X X

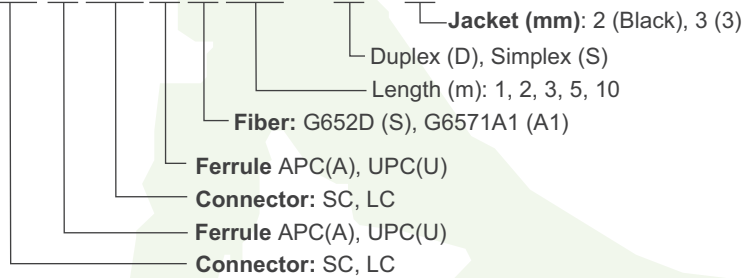

PRODUCT DATA SHEET

ADAPTERS & CONNECTORS

Fiber Optic Fast Connector

The optical fiber connector that requires no epoxy and no polishing. Design of the patented mechanical splice body incorporates a factory-mounted fiber stub and a pre-polished ceramic ferrule. This technology provides a fast, secure and reliable SC or LC compatible optical fiber termination SM cable mechanical performance.
Options ferrule UPC or APC

Features:

- Precision mechanical dimension
- Fast, easy to installation
- Low insertion loss
- Ultra low back reflection
- Conforms to IEC61754-4
- All materials conform to RoHS

Ordering Information

Part Number	Connector	Ferrule Type
NTFCPPSCUS	SC	SC
NTFCPPSCAS	SC	SC
NTFCPPLCUS	LC	LC
NTFCPPLCAS	LC	LC

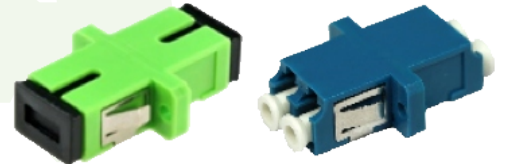

Fiber Optic Adapter

Nitrotel fiber adapters are manufacturing with strictest industry standards.
Options

Features:

- Meets ANSI/TIA-568.3-E component performance specifications
- Come with flanges, option w/o flanges
- Green or Blue, SC simplex or LC duplex
- Standard with flanges, optional w/o flanges

Ordering Information

NTFAXX X X X

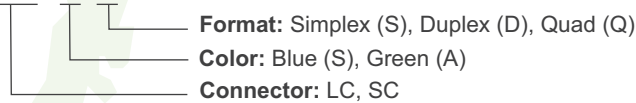

PRODUCT DATA SHEET

END TERMINATION

Modular Optical Distribution Frame (ODF)

The Fiber Optic Patch Panels, crucial part of the EngineerPro™ fiber solution, come in various sizes (1U, 2U, 3U and 4U) to fit 19-inch (483mm) wide rack mounted systems. These panels can accommodate industry-standard LGX adapter modules or LGX cassette modules from Nitrotel or other vendors.

Features:

- Large, translucent window provides clear view of the patching field.
- Splice Trays (2,4,6 or 8)
- Complete front and back panel access to any/all modules in the panel.
- Excellent cable management
- Trunk cable holders (Available only in 2U, 3U & 4U Patch Panels)
- Complete installation hardware

Ordering Information

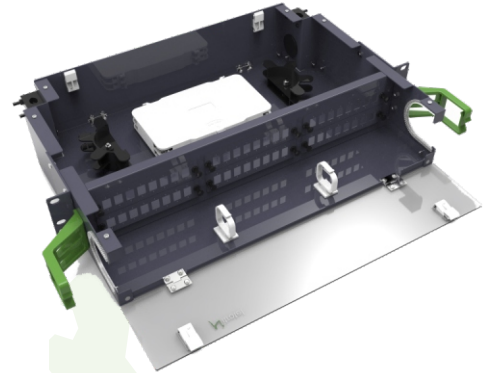

Plates

Nitrotel fiber adapter modules are compatible with LGX plates. Fiber adapters will support diverse applications like SM or MM, UPC or APC, simplex, duplex or quad format

Ordering Information

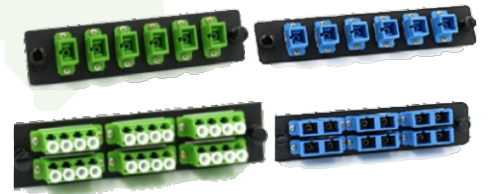
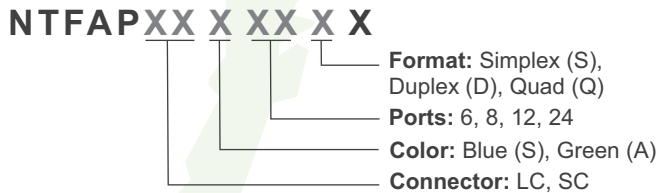

Basic Optical Distribution Frame

Nitrotel ODF comes in 1U 19-inch-wide rack and optic splicing tray in it. Drawer design, made of armor plate of high quality. Two options available: 24 SC simplex or 12 SC duplex

Features

- Pigtail fusion splicing (Splice Tray)
- Complete front and back panel access (sliding)
- Options LC duplex instead SC simplex

Ordering Information

NTFPPSC24PSXY 24 SC Simplex

NTFPPLC12PDXY 12 LC Duplex

Y Color: Blue (U), Green (A)



Wall Mount mini ODF

Nitrotel mini fiber optic distribution box is used for fusion between indoor optical cables or drops and pigtails, using SC simplex or LC duplex fiber adapters. Made of high-quality plastic material, it is easy to instal.

Features

- Dimension (L*W*H): 100*80*30mm
- Weight: 53g
- Adapter capacity: 4
- Adapter type: SC simplex or LC duplex (w/o flanges)

Ordering Information

NTMB04FWH



FTTH Fiber Optic Faceplate, 1 or 2 Ports

Fiber Optic Faceplate (86*86) It enables various module installations, facilitating dual or single core fiber access and port output. It provides fiber termination and protection, suitable for FTTH termination. Constructed from high-quality ABS plastic, it offers anti-collision, flame retardant. It can be wall-mounted.

Features

- One or Two square holes in the box for adapter and cable fixation ensuring reliability.
- Embedded frame for easy installation and disassembly.
- Compatible with SC or LC simplex duplex.
- Storage space for butterfly cable for proper bending radius

Ordering Information

Part Number	Ports	Adapter
NTFFP-01	1	Empty
NTFFP-01X	1	APC X=A, UPC X=U
NTFFP-02	2	Empty
NTFFP-02X	2	APC X=A, UPC X=U



FUSION & SPLICING

Fully Automatic Fiber Fusion Splicer

The Nitrotel NTFFSM-840 fully automatic fiber fusion splicer is a high-performance and advanced fiber optic connectivity device designed specifically for the field of fiber optic communication.

Equipped with 6 motors and a touchscreen interface, it employs the latest optical technology and automated control systems to achieve fast and precise fiber fusion, providing reliable and efficient solutions for the construction and maintenance of fiber optic communication networks

Features:

- Fiber Type: SM (G.652 / G.657), MM (G.651), DS (G.653), NZDS (G.655), EDF, BIF / UBIF
- Alignment: Core alignment, Clad alignment
- Splice Time: 9 seconds (Typical Mode)
- 7 seconds (Fast Mode)
- Loss: 0.02dB (SM), 0.01dB (MM), 0.04dB (DS), 0.04dB (NZDS)
-

Ordering Information

NTFFSM-840



PRODUCT DATA SHEET

TERMINATION TOOL

Fiber Optic Cleaver

This Nitrotel cleaver provides precise and smooth cutting, suitable for both hot fusion and cold junction applications. Constructed with durable metal material.

Features

- Cutting length: 9 – 16mm (diameter 0.25mm), 10 – 16mm (indoor fiber), 9 – 16mm (diameter 0.9mm)
- Fiber diameter type: 125um
- Suitable for single-core fiber
- Blade lifespan: Approximately 50,000 cuts

Ordering Information
NTFOC02



Preparation cables

Nitrotel Offer best quality of tools for preparation of cables

NTFST125 Jacket Stripper 900,250um

NTFTSC-100 Kevlar Scissor

NTFTBS-3MM Loose Tube Stripper 2 to 3 mm

NTFTST-FTTH Drop Cable Stripper

NTFTSLT-520 Round Slitter Cable

NTFOCLR-25 Connector Tip Cleaner 2.5mm

NTFOCLR-125 Connector Tip Cleaner 1.25mm



Optical Time Domain Reflectometer

Nitrotel OTDR series 3000 with 5-inch HD capacitive screen boasting a full touch-screen design, it delivers lightning-fast image processing. Large-capacity Li-battery. Streamlining operations with one-button testing, its event mapping feature enables intelligent link analysis. Expandable up to 150GB with a U disk, it offers ample trace storage. Supporting multiple wavelengths. Capable of conducting tests under weak light conditions, it maintains versatility in various settings.

Features

- Pulse Width 10ns, 20ns, 50ns, 100ns, 300ns, 1.0us, 2.5us, 10us, 20us, 25us
- Event Dead Zone (m) 2
- Attenuation Dead Zone (m) 10
- Distance Range (km) 0.5 - 160
- Loss Measurement Accuracy $\pm 0.05\text{dB/dB}$
- Date Sampling Point 12800
- Memory Capacity 1000 Curves
- Fiber Type Single-mode
- LCD Size 5-inch HD color touch screen
- Capacity of Screen Touches > 10 million times
- Standard Interface FC / SC / ST / LC optional
- Distance Uncertainty $\pm (1 + 0.005\% \times \text{distance} + \text{sampling resolution})$

Ordering Information
NTOTDR-3000A

